



上海创馨科技（集团）有限公司

创业孵化+电子研发工程服务



关于上海创馨科技1ST-LABS

1ST-LABS



专注于电子类产品研发工程服务

致力于提升研发质量及生产效率

TÜV认证企业，专业的运营管理

打造创业孵化全方位专业支持平台

累计服务超过 6000 家科技企业



创馨科技质量体系 及 专注领域

1ST-LABS



ISO13485

医疗

TÜV IATF16949

汽车

TÜV ISO9001

质量

ISO14001

环境



医疗电子



汽车轨交



工业控制

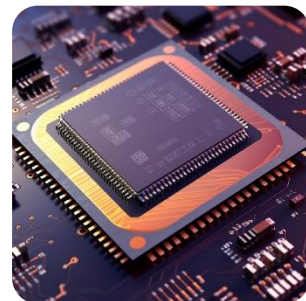

半导体芯片

创馨科技1ST-LABS 平台架构

1ST-LABS



上海创馨科技(集团)有限公司
Shanghai 1ST-LABS Technology (group) Co.,Ltd.

1ST-LABS



incubation & RD Service platform
investment management

电子研发工程服务体系投资管理

上海凝睿电子科技有限公司



Craftsman

Products Design, Embedded system,
PCB Layout, Products Optimize

产品设计, 嵌入式软硬件开发,
电路板设计, 产品优化

凝智企业管理咨询(深圳)有限公司



Focus-Talents

Technical Experts,
Human Resources

技术专家及人力资源

凝昊电子科技(上海)有限公司



KnowHow-Tech

PCB,Components,Pilot Run/MP
SMT/PCBA,Testing,BGA Rework,
CNC,Tooling,Product Manufacture

电子产品柔性智能制造工厂

凝垣企业管理(上海)有限公司



IP-Plant

IP Application & Management
High-tech enterprise identification
and innovation fund consultant

企业知识产权规划及管理
高企认定及创新基金顾问

创馨科技运营分布

1ST-LABS



研发中心



运营总部



量产基地

西安研发分公司

1ST-LABS



西安市雁塔区
绿地蓝海大厦16楼



前台



办公区域

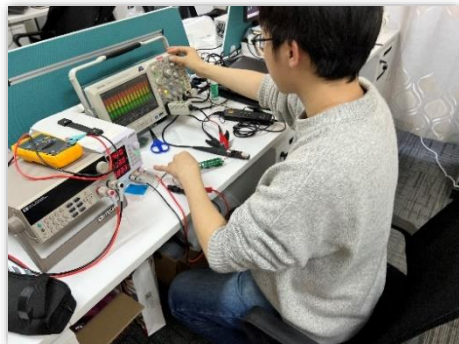

实验室

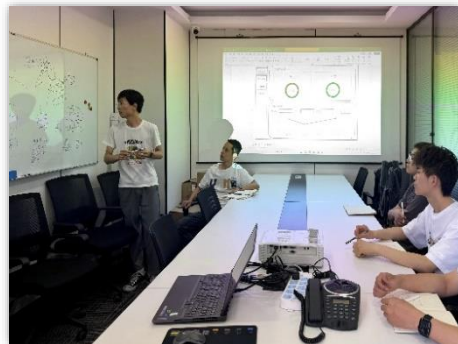

会议室

创馨科技1ST-LABS 电子研发工程服务

1ST-LABS

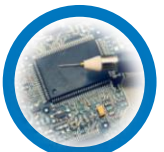
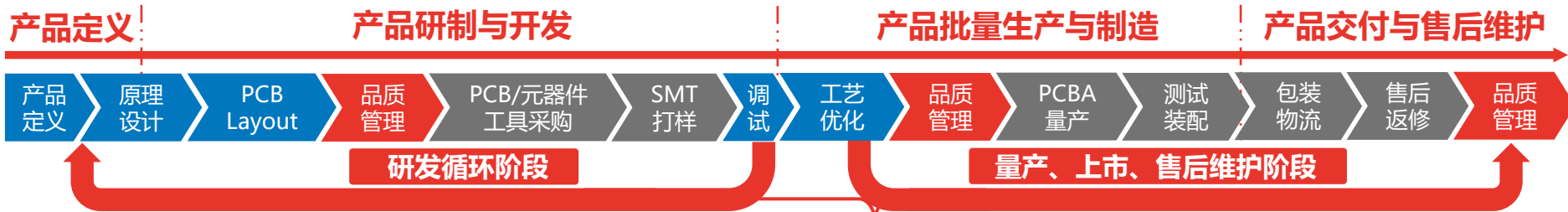

硬件原理设计



嵌入式软件

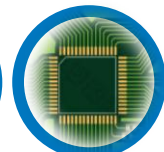

PCB Layout

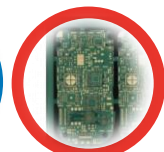

PCB 制板



元器件采购



研发SMT打样



品质管理



芯片真伪对比库



批量PCBA制造



测试与装配

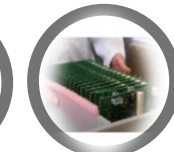

包装与物流



产品开发



产品加密保护

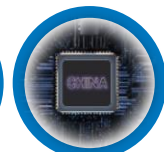

国产替代设计



BGA植球



BGA飞线



BGA返修



3D打印



DFT/DFM



售后维修服务



器件分析



数字化逆向

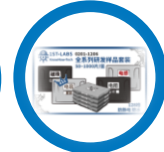

研发工具



芯片Decap开盖



创业资源管理



技术专家服务



CNC加工



知识产权顾问



高企申请顾问



知识产权授权管理



具体业务介绍



研发流程管理

原理图设计
封装库规范
PCB布局与走线

01

STEP

材料品质管理

PCB加工
元器件采购
生产耗材采购



02

STEP



Quality
Control

STEP

04

生产制造

生产工艺管理
SOP及过程控制
功能与性能测试



STEP

03

DFT/DFM

可测试性设计
可制造性设计
系统工艺优化



参与研发，提前介入工艺优化

从零部件到生产工艺全程管控

参与制定ICT与FCT测试方案

TÜV管理体系，卓越良率水平

提供低总体成本的高品质交付

创馨科技 1ST-LABS – 芯片真伪对比库

1ST-LABS

自建真品数据库

器件丝印型号对比

器件厚度对比

X-Ray结构对比

Decap硅片对比

引脚阻抗测量对比

器件功能及性能测试

芯片真伪对比库

搜索 型号: 品牌: 封装: 批次: 取消筛选 操作: 添加(A) 编辑(E) 删除(D) 关闭(Q)

序号	规格型号	品牌	封装	批次	标准丝印正面	标准丝印反面	X-ray结构标准图	Decap标准图	阻抗表	规格书
20	ADS1118IDGSR	TI(德州仪器)	SSOP-10-0.5mm	2329+	查看	查看	查看	查看	查看	查看
19	ADA4505-2ARMZ	ADI(亚德诺)	MSOP-8	2307+	查看	查看	查看	查看	查看	查看
18	TPS73001DBVR	TI(德州仪器)	SOT-23-6	2329+	查看	查看	查看	查看	查看	查看
17	MAX13487EESA+	亚德诺/MAXIM	SOIC-8	2407+	查看	查看	查看	查看	查看	查看
16	ISO7221ADR	TI(德州仪器)	SOIC-8	2310+	查看	查看	查看	查看	查看	查看
15	SN74LVC14APWR	TI(德州仪器)	TSSOP-14	2337+	查看	查看	查看	查看	查看	查看
14	STM32F103C8T6	ST(意法半导体)	LQFP-48(7x7)	2332+	查看	查看	查看	查看	查看	查看
13	NCV1117D733T5G	onsemi(安森美)	O-252-2(DPAK)	2402+	查看	查看	查看	查看	查看	查看
4	BTS7223GW	INFINEON	SOIC-14	2237	查看	查看	查看	查看	查看	查看
1	AD9508RSZ	DIGIKEY	28SSOP	2228	查看	查看	查看	查看	查看	查看

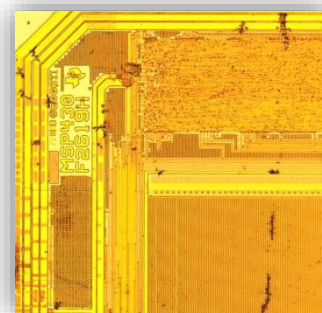
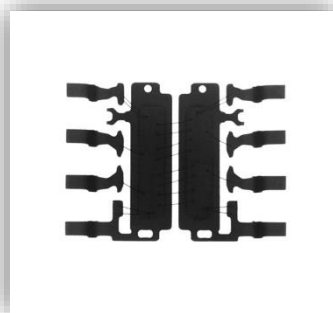
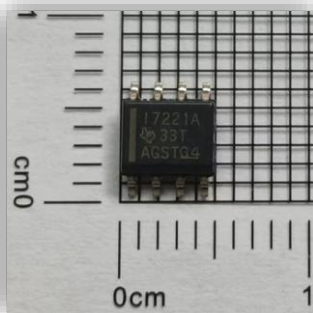

功能	引脚号	对地阻抗
Vbb	1	8.8MΩ
IN1	2	51.7KΩ
ST1	3	11.3MΩ
ST2	5	1.65MΩ
IN2	6	0.52KΩ
Vbb	7	8.7MΩ
Vbb	8	8.8MΩ
OUT2	9	∞
OUT2	10	∞
SPU	11	3.9MΩ
OUT1	12	∞
OUT1	13	∞
Vbb	14	8.8MΩ



MCU/ARM

采用业内领先的超低功耗架构芯片，实现更加稳健高效的互联互通，在工业产品、云连接、人工智能等领域研发产品，提供完整解决方案。



FPGA

提供FPGA逻辑设计、FPGA相关电路开发、嵌入式系统设计、高频/高速板卡、样机或样板以及批量委托生产等一条龙服务。



人机交互

提供丰富的人机交互软硬件设计解决方案，包括电阻屏、电容屏、触摸控制、人机控制接口、信息反馈、执行机构等、以满足各种的设备交互控制要求。



DC/DC电源

铁路，交通，恶劣环境的工业控制，超低噪声采样系统供电，低噪声和EMI指标的医疗设备电源产品设计，调试，认证，量产一站式服务

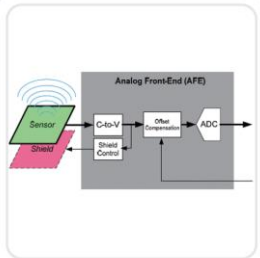

模拟AFE

丰富的传感器信号采集，小信号处理，低噪声放大电路，低时延、高精度基准源，高精度ADC采样、多通道实时采样等电路研发设计、生产制造经验。



嵌入式C

Verilog

Linux

FreeRTOS

QT

编程平台

PID

电机驱动

编码器

运动控制

人机界面

算法开发

凝睿(EECraftsman) – PCB Layout

1ST-LABS

cadence

Altium
Designer.

深谙DFT与DFM的精髓

内部标准库管理系统

结合自有产线验证优化

精雕细琢的设计匠心



凝睿(EECraftsman) – PCB Layout

1ST-LABS

- 26+ 层通信基板
- FPGA
- CPLD
- DDR4
- 低压大电流电源

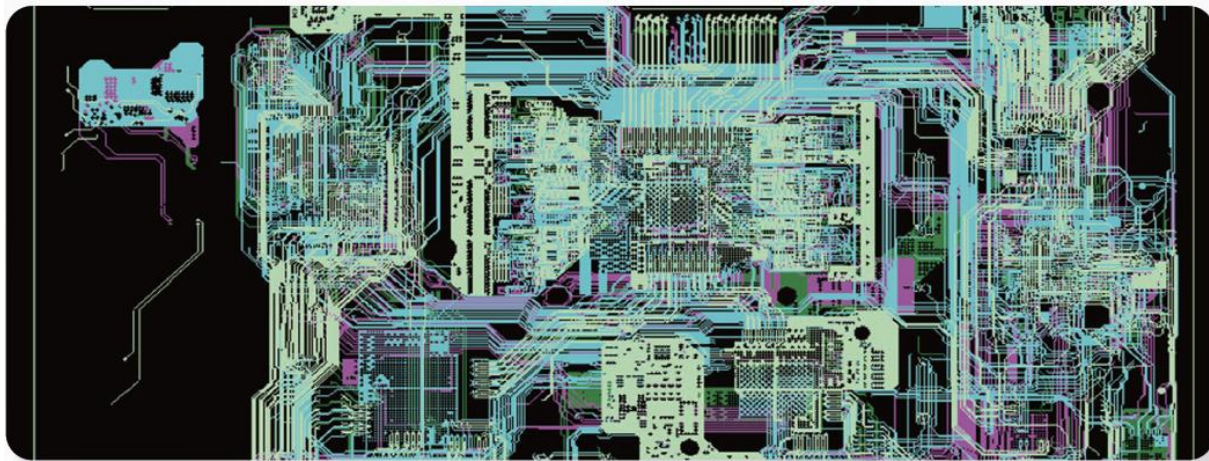

- HDI
- 8 层盲埋孔
- 激光钻孔
- 高精度

0.33oz	1/3 O.Z.	1.1mil
0.33oz	106 (76%)	2.05mil
0.33oz	1/3 O.Z.	0.9mil
0.33oz	106 (76%)	2mil
0.33oz	1/3 O.Z.	1mil
0.33oz	106 (76%)	2.1633mil
0.5oz	0.19mm(0.16mm) HH	7.4mil (6.1)
0.5oz	106 (76%)	2.1633mil
0.33oz	1/3 O.Z.	1mil
0.33oz	106 (76%)	2mil
0.33oz	1/3 O.Z.	0.9mil
0.33oz	106 (76%)	2.05mil

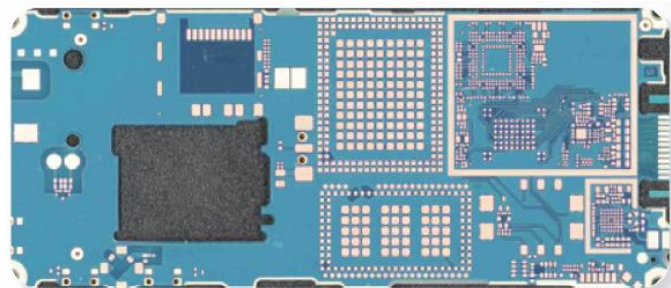



医疗电子

- 精密步进控制系统
- 高性能低噪声LED光源
- 生物体内无线数据传输
- 超低功耗模拟前端
- 采样处理及算法优化等软硬件技术
- 穿戴式医疗设备
- 超微型化设计与生产



汽车轨交

- 器件选型及冗余设计
- 稳定性和可靠性设计
- 三防及加固
- 软硬件冗余性
- 板卡EMI优化处理
- 加密与安全
- 系统化集成与防呆结构

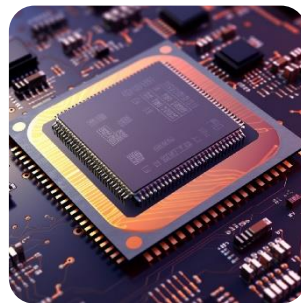

半导体芯片

- 划片、快封
- 裸片测试板设计
- 封装后测试板设计
- 测试系统PCBA
- DEMO板设计
- 应用开发支持
- 模块设计与批量交付



工业控制

- 传感器优化
- 有线传输接口
- 无线传输接口
- 电机驱动
- 人机交互接口
- 边缘计算节点
- 可靠性及稳定性
- 恶劣环境三防处理
- CCC, UL, CE认证服务

凝睿(EECraftsman) – SHA256加密解决方案

1ST-LABS



抄板

解密

仿制

克隆

★
芯片读取保护

★★
数据总线熔断

★★★
程序代码加密

★★★★★
唯一ID校验

★★★★★★
专用加密芯片

EECraftsman
基于SHA256开发
加密解决方案
硬件芯片+算法库

目前理论上无法
破解

凝睿(EECraftsman) – SHA256加密解决方案

1ST-LABS

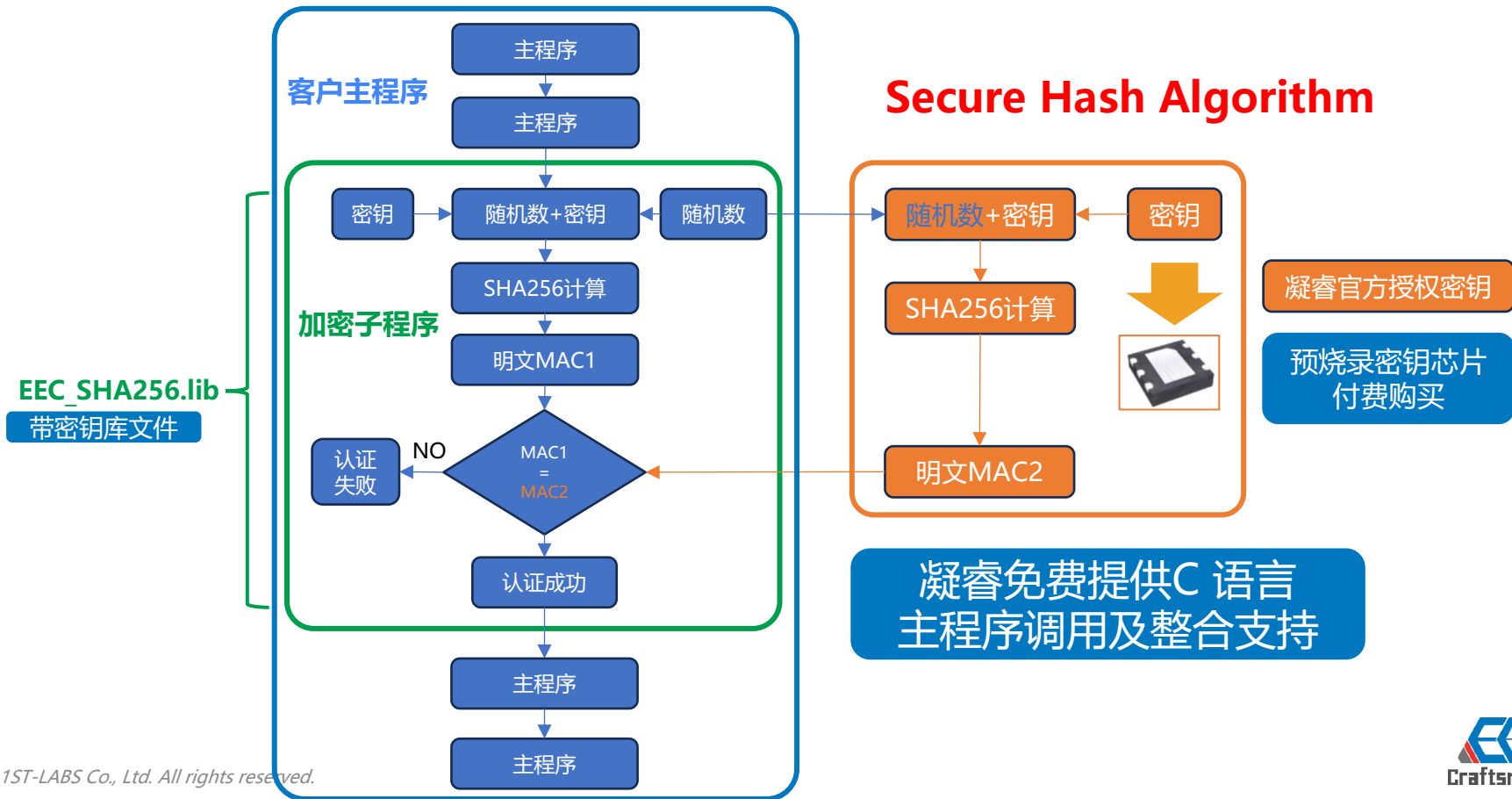

凝睿(EECraftsman) – 国产替代设计

1ST-LABS

降低产品整体成本

解决物料供应紧缺

模拟电路国产替代

数字电路国产替代

性能测试与验证

国产MCU代码移植

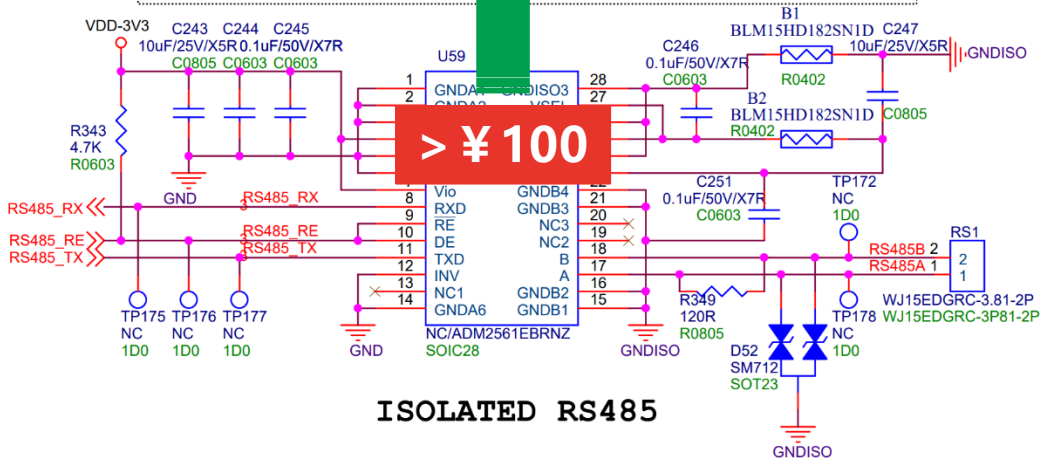
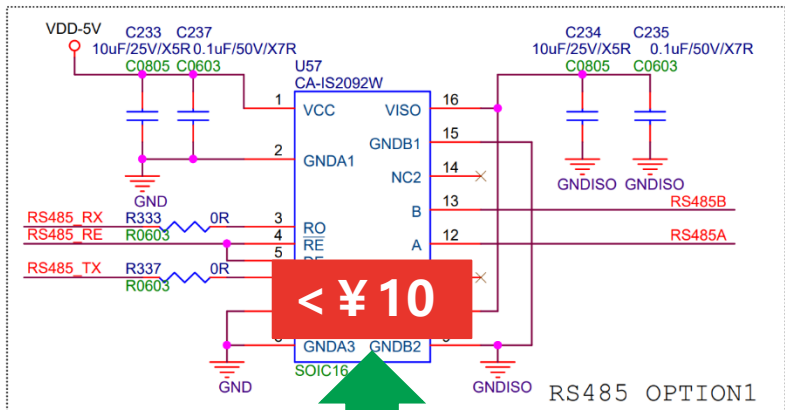

凝睿(EECraftsman) – 器件分析

1ST-LABS

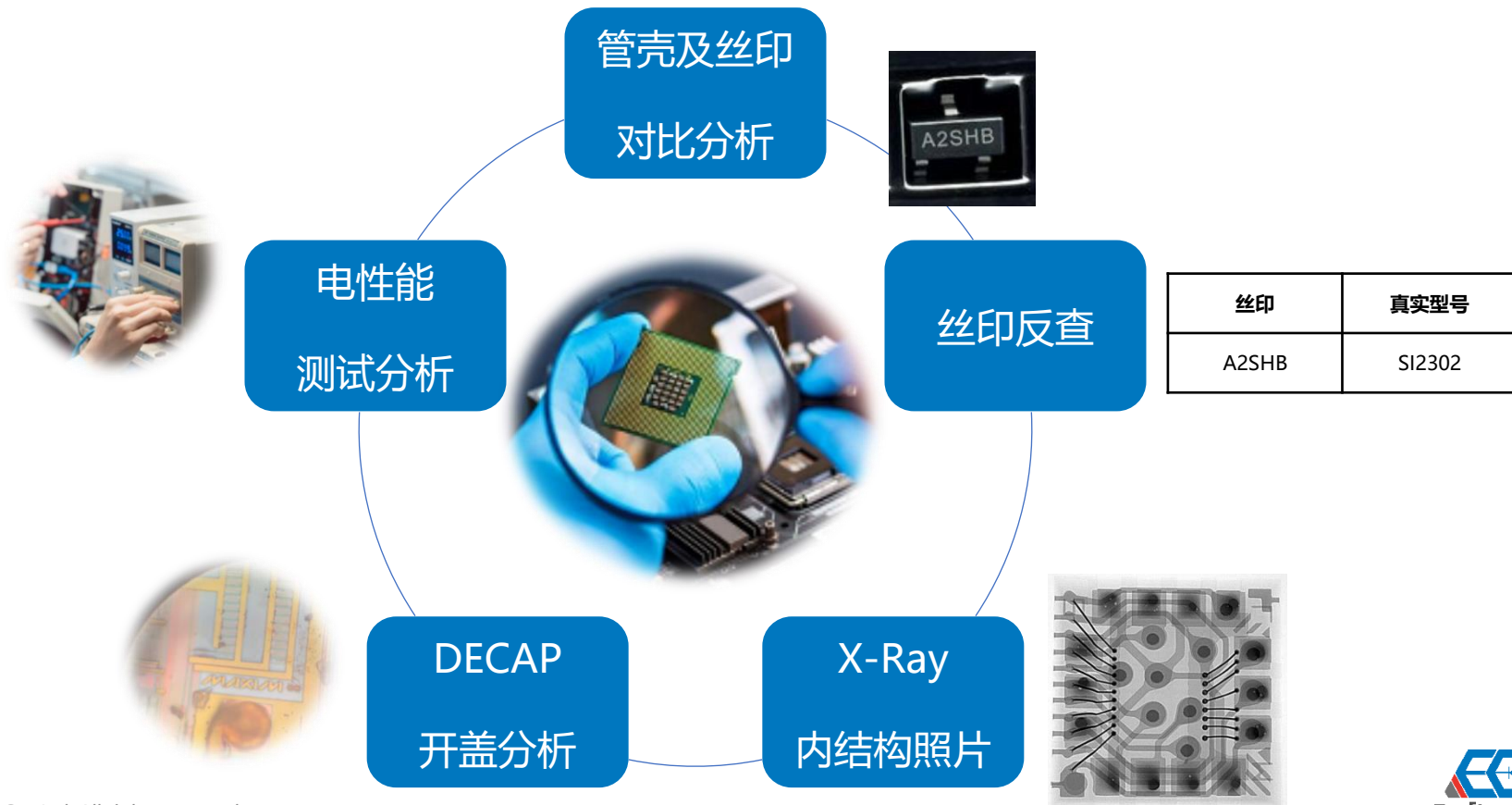

凝睿(EECraftsman) – 数字化逆向分析

1ST-LABS

精细机械打磨
激光扫描
数字化建模

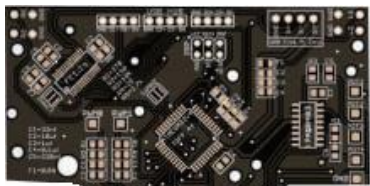

原理图建库
网络重建
原理图反推

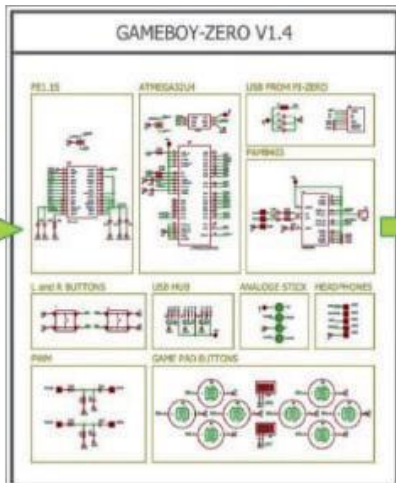

重建Gerber
重建网络表
测量器件参数



芯片丝印反查
芯片DECAP分析
芯片代码读取

**客户需声明对逆向分析产品的法律合规性
凝睿不承担任何法律风险与责任**

研发调试阻容套装



元器件盒整体规格: L28cm*W24.5cm*H4.2cm,



单单元格规格: L2cm*W1.5cm*H2cm, 可容纳0603封装的电阻3000多片。

原装正品

完整品类

现货库存

电阻系列

0201

0402

0603

0805

1206

1% 128值(单盒) 0Ω-1M

5% 170值(2盒) 0Ω-10M

1% 484值全系列(4盒套装)0Ω-10MΩ

电容系列

0201 52值 0.5pf-0.22μf

0402 68值 0.5pf-2.2μf

0603 73值 0.5pf-10μf

0805 66值 1pf-22μf

NR-2501

NR-2308



电路信号测试针



淘宝商城

凝智(Focus-Talents)-创业资源管理

1ST-LABS



创业孵化资源管理服务

人力资源托管

数据中心建设

人才资源能力评估

产业政策及园区政策

法务及仲裁纠纷处理支持

企业管理制度顾问服务

TECHNOLOGY EXPERT



关键技术的专家顾问服务

低噪声电源

高精度ADC采样

低压大电流DC/DC

EMI & EMC

手持设备低功耗设计

失效分析

其它专业技术

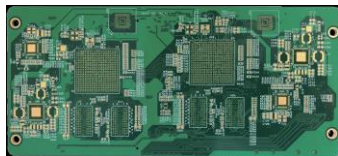

PCB制造管理专家

实地考察认证合作工厂

工厂规模

设备精度

质量体系

交付速度

工艺水平

行业口碑

按设计确定匹配工厂

专业DFM工艺调整

处理PCB的工程EQ问题

VIP大客户成本控制

品质优先的快速交付

工艺
分析



品质
控制



交付
管理

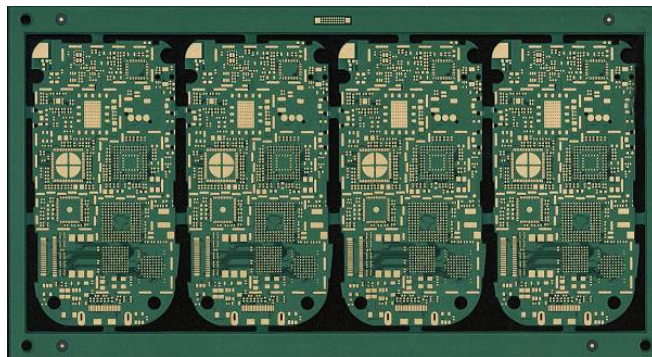

最高46层板

高TG板材

3mil 线宽线距

30:1厚径比

HDI盲埋孔

刚柔结合版

最高60Z铜厚

最大7mm板厚

罗杰斯高频板

铝基板

FPC板

阻抗匹配

常规器件，现货库存

原装正品

4000+类

现货库存



委托集采

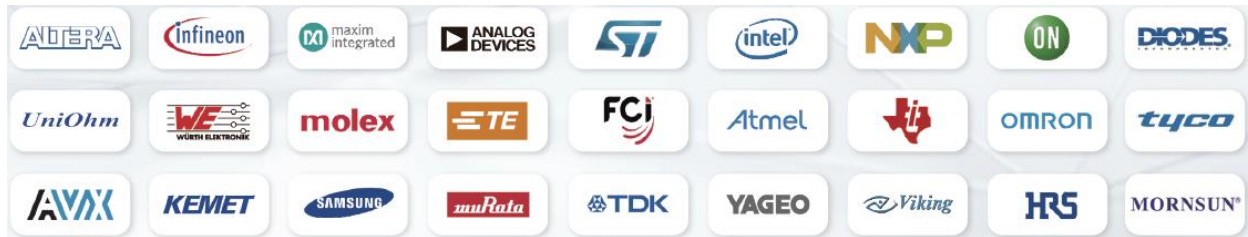

小批量/样品分销商渠道

批量代理/代理商渠道



凝昊(KnowHow-Tech) – 研发SMT打样

1ST-LABS

杀鸡也可用牛刀

智能化柔性智造工艺

规范化的质量管理体系



专注研发
快速打样



一片起焊
无最低消费



先进工艺
专业品质



72小时快速交付
24小时睿捷交付



ISO13485

TÜV ISO9001

ISO14001

TÜV IATF16949

环保免钢网
智能调节喷锡量



X-Ray
快速点料



瑞士Y-700
锡膏喷印



三星481贴片机
飞达车换线



三星482贴片机
飞达车换线



德国ERSA 14温区
支持氮气回流焊

凝昊(KnowHow-Tech) – 研发BGA飞线返修

1ST-LABS

24小时快速维修

IPC认证维修技工

补救设计错误

缩短调试时间

降低研发成本

提高研发效率



BGA飞线

BGA内飞, BGA向外引线

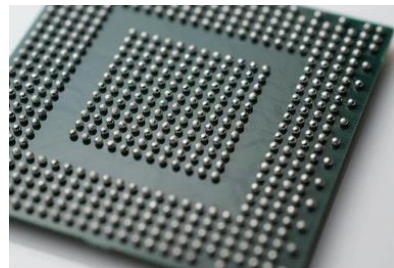

BGA拆焊、植球、返修

BGA, LGA, CSP, WCSP



日本DC返修工作站

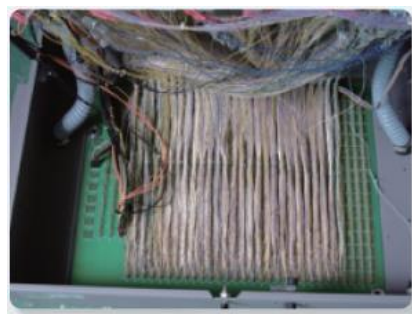
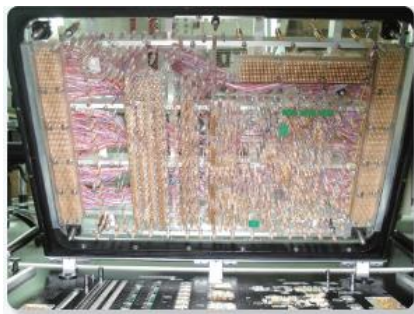

案例：IC测试系统，28层PCB，上千条线，重要核心Socket无损维修



芯片型号分析

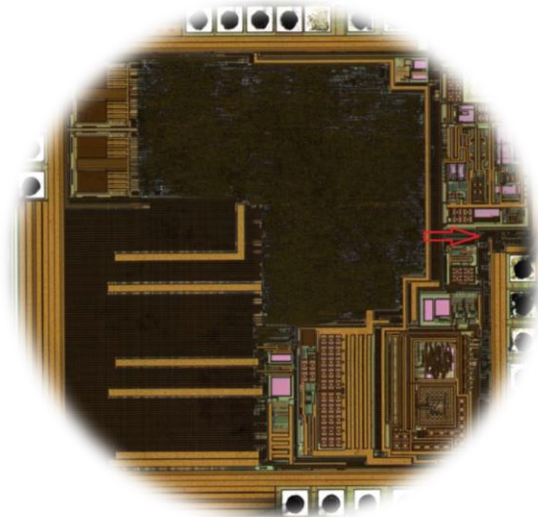
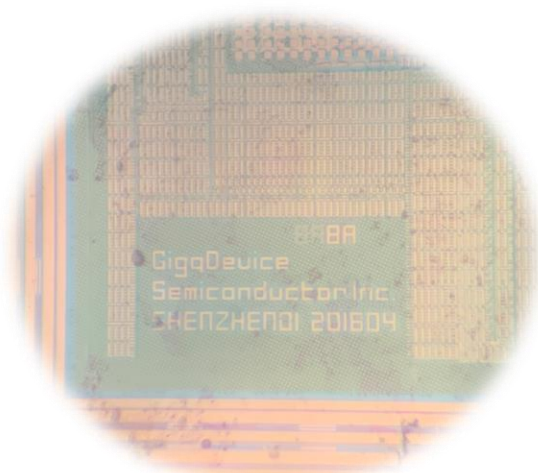
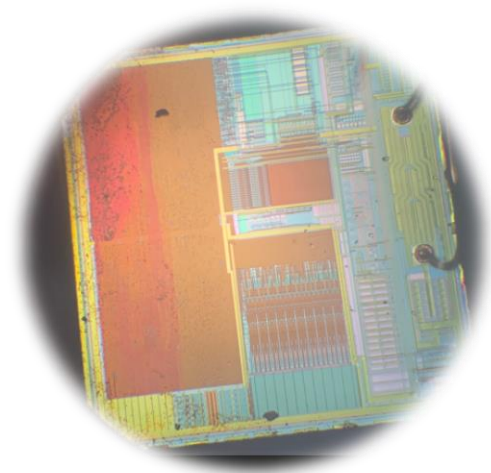

研发3D打印及小批量CNC

3D打印机 / 专业CNC加工中心 (30台)



3D结构打印, 尺寸误差 $\pm 0.1\text{mm}$



CNC精密加工中心, 尺寸误差 $\pm 0.02\text{mm}$

量产工艺优化

研发转量产的专业服务

可制造性

可装配性

批量良率

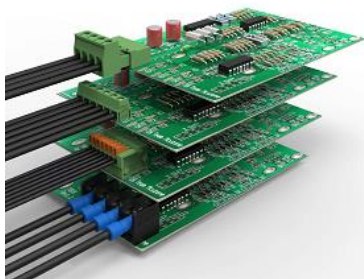

装配可靠性优化

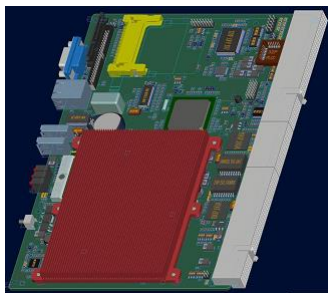

结构工艺优化

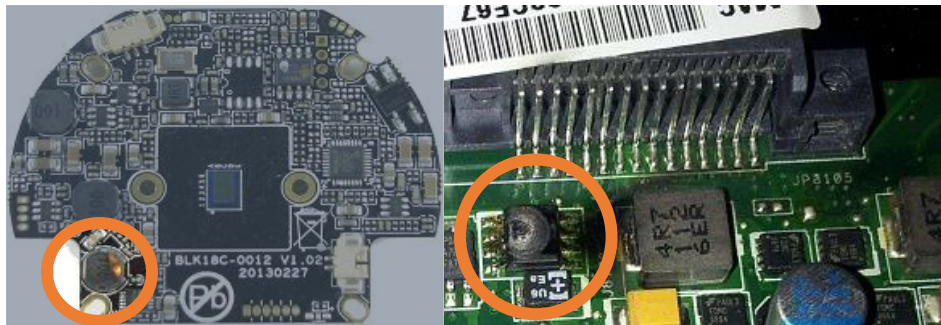

失效分析、静电防护优化、应力释放优化



批量生产制造工艺DFT/DFM优化、直通率与良率优化

凝昊(KnowHow-Tech) – 批量PCBA制造

1ST-LABS

标准化批量制造

规范化的质量管理体系



ISO14001

TÜV ISO9001

TÜV IATF16949

ISO13485



X-Ray点料



GKG锡膏印刷



锡膏喷印局部优化



SPI锡膏检测



JUKI 贴片机



劲拓12+3温区氮气双轨回流焊



AOI检测

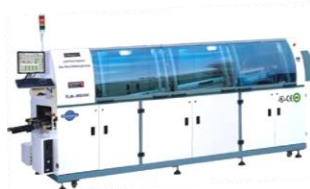

波峰焊



首件检测仪



X-Ray分析

单日满负荷贴装产能100万器件

凝昊(KnowHow-Tech) – 测试及装配

1ST-LABS

完整产品制造

规范化的质量管理体系



ISO14001

TÜV ISO9001

TÜV IATF16949

ISO13485



测试夹具、工装治具设计及加工

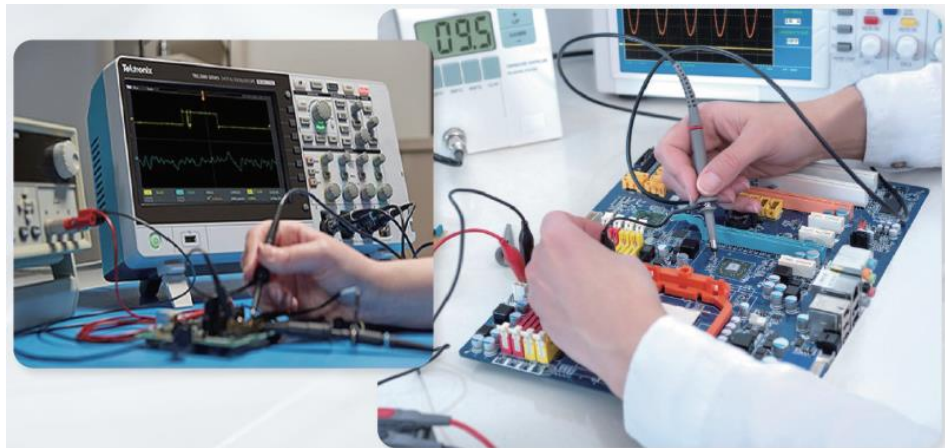

性能测试



整机装配

小微企业一站式产品服务

包装定制、仓储管理、物流协助



批量板卡转运框架、缓冲材料及包装定制



6226 0112 7758 2334 250

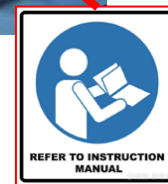



故障分析

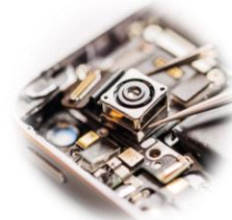
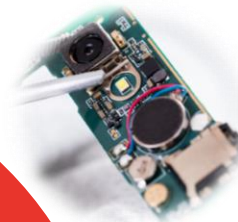

批量返修

原理对比

IPC持证维修技工

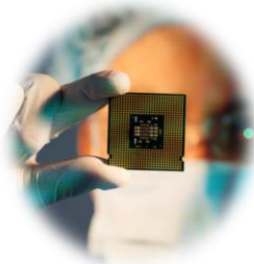
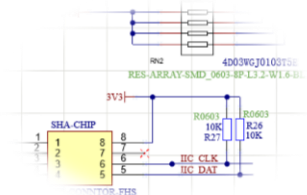

BGA返修

芯片级维修



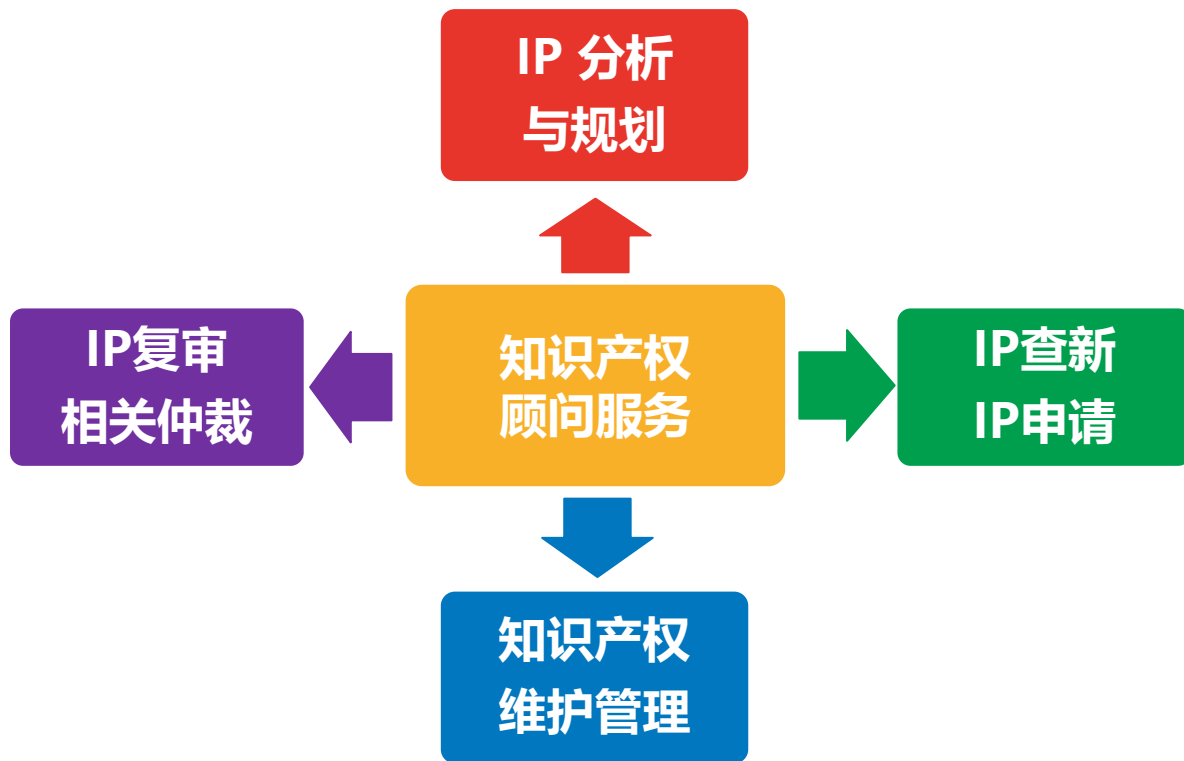

凝垣(IP-Plant)-高新技术企业申请顾问

1ST-LABS



政策实时解读

- 关注实时信息
- 更新政策解读

知识产权规划

- 专利挖掘与申请
- 创新管理及规划

申报资质

- 指导相关材料准备
- 材料合规性检查

一站式服务

- 长期发展规划
- 全流程顾问服务

6-28个月 知识产权申请管理 《 申请规划、申请辅导、顾问服务 》 项目增值

注册商标

商标设计

版权

软件著作权

外观专利

实用新型专利

发明专利

集成电路版图



创新基金
申请

20万起

品牌提升

高新技术企业
申请

高新补贴5万起

税务减免

小巨人60万起

融资贷款

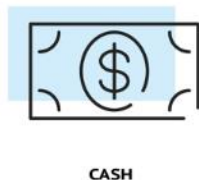

01

价值规划

研发阶段介入规划
申请代办

02

节省时间

行业目标客户数据库
精准匹配, 高效省时

03

价值回报

专业分析与估值
价值最大化

04

专业管理

专业法务团队
专业管理团队

知识产权授权管理顾问服务

知识产权交易顾问服务



Thanks !

创馨科技集团： 创业孵化及电子研发工程服务